



FAG

NTC38 [↗](#)

Anillo obturador

Taconite seals NTC, for SNS-housing,
kombined sealing

Información técnica

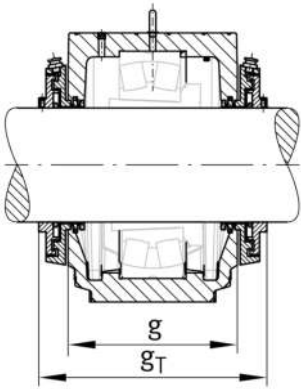

Medidas principales y datos de rendimiento

d	170 mm	Diámetro del eje
b	69 mm	Anchura
g	36 mm	Saliente exterior
d _a	282,5 mm	Diámetro exterior
≈m	7,2 kg	Peso