



FAG

BND3152-Z-Y-AF-D

Cuerpo de soporte

for bearings with cylindrical bore, BND

Información técnica

Medidas principales y datos de rendimiento

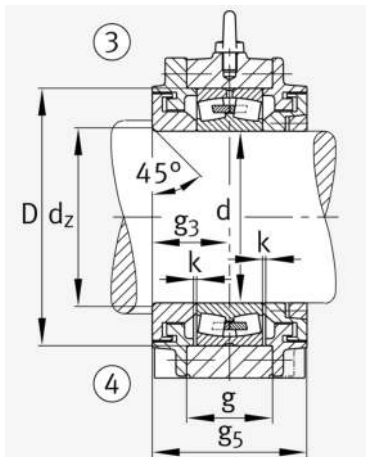
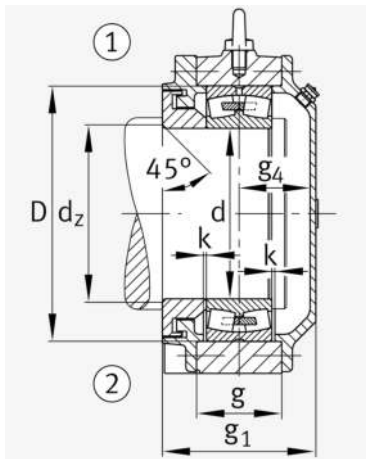

d 1	260 mm	Diámetro del eje
a	900 mm	Longitud de la base
h 1	585 mm	Altura total
g 1	292 mm	Anchura total
g 5	300 mm	
≈m	294 kg	Peso

**Medidas**

	45 °	Chamfer angle
b	250 mm	Anchura de la base
c	90 mm	Height base foot
D	440 mm	Outside Diameter
d _c	276 mm	Chamfer diameter c
g	174 mm	Anchura del cuerpo de soporte
g ₃	150 mm	Locking collar width g3
g ₄	132 mm	Anchura del anillo tensor g4
h	290 mm	Distance shaft axis
k	4 mm	Axial displacement
m	750 mm	Distance fixing bore
n	140 mm	Bore distance width
s	M36	Tamaño de los tornillos de fijación
s ₂	M20	
s ₂	8	Número de agujeros roscados
t	510 mm	Diámetro primitivo de rodadura de los agujeros de fijación
u	42 mm	Anchura del agujero alargado
v	52 mm	Lenght oblong hole

Información adicional

	23152	Referencia rodamiento
--	-------	-----------------------

Rango de temperatura

T _{min}	-20 °C	Temperatura mín. de funcionamiento
T _{max}	100 °C	Temperatura máx. de funcionamiento

