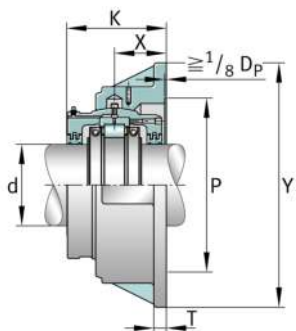
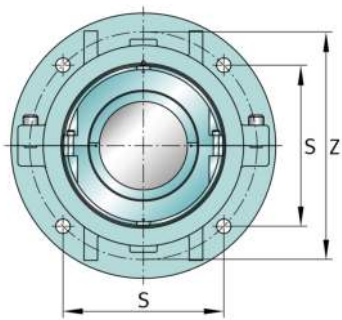

**FAG****S2BCF-1208-HD**

Soporte de apoyo

Soporte-bridá

Información técnica

**Medidas principales y datos de rendimiento**

d	≈ 317,5 mm	Shaft diameter
Y	≈ 914,4 mm	Flange outside diameter
K	≈ 355,6 mm	Width
≈m	635,029 kg	Peso

Medidas

	S2BCF-1208-HD	Complete unit held
	S2BCF-1208-FL	Complete unit float
	FH-29	Housing designation
X	≈ 190,5 mm	Bearing centerline location
Z	≈ 800,1 mm	Bolt circle diameter
S	≈ 565,15 mm	Bolt hole distance
T	≈ 44,45 mm	Thickness of flange
P	≈ 679,45 mm	Pilot counterbore diameter
S	8	# of Mounting Bolts
S	≈ 31,75 mm	Mounting bolt diameter