



FAG

NTC92 [↗](#)

Anillo obturador

Taconite seals NTC, for SNS-housing,
kombined sealing

Información técnica

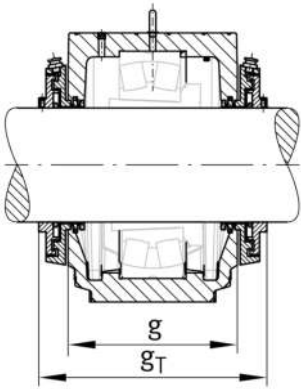

Medidas principales y datos de rendimiento

d	430 mm	Diámetro del eje
b	77 mm	Anchura
g	44 mm	Saliente exterior
d _a	548,5 mm	Diámetro exterior
≈m	25,3 kg	Peso