



FAG

BND2234-Z-Y-BF-D

Cuerpo de soporte

for bearings with cylindrical bore, BND

Información técnica

Medidas principales y datos de rendimiento

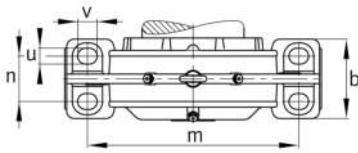

d 1	170 mm	Diámetro del eje
a	640 mm	Longitud de la base
h 1	405 mm	Altura total
g 1	216 mm	Anchura total
g 5	236 mm	
≈m	101 kg	Peso

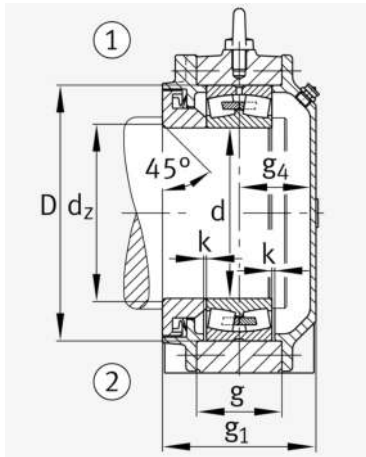
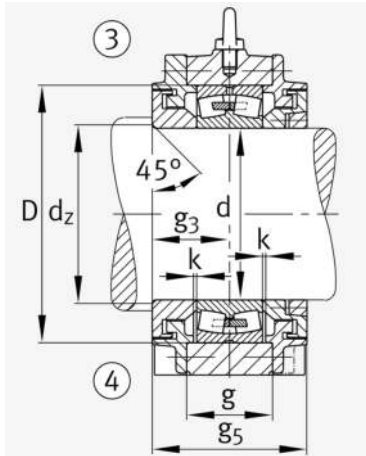
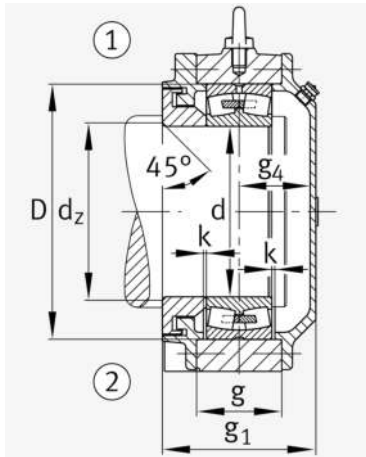
**Medidas**

	45 °	Chamfer angle
b	200 mm	Anchura de la base
c	62 mm	Height base foot
D	310 mm	Outside Diameter
d _c	186 mm	Chamfer diameter c
g	111 mm	Anchura del cuerpo de soporte
g ₃	118 mm	Locking collar width g3
g ₄	88 mm	Anchura del anillo tensor g4
h	200 mm	Distance shaft axis
k	3 mm	Axial displacement
m	525 mm	Distance fixing bore
n	110 mm	Bore distance width
s	M30	Tamaño de los tornillos de fijación
s ₂	M16	
s ₂	8	Número de agujeros roscados
t	350 mm	Diámetro primitivo de rodadura de los agujeros de fijación
u	36 mm	Anchura del agujero alargado
v	45 mm	Lenght oblong hole

Información adicional

	22234	Referencia rodamiento
--	-------	-----------------------

Rango de temperatura

T _{min}	-20 °C	Temperatura mín. de funcionamiento
T _{max}	100 °C	Temperatura máx. de funcionamiento

