



**FAG**

### **BND3132-Z-T-AF-D**

Cuerpo de soporte

for bearings with cylindrical bore, BND

## Información técnica

### Medidas principales y datos de rendimiento

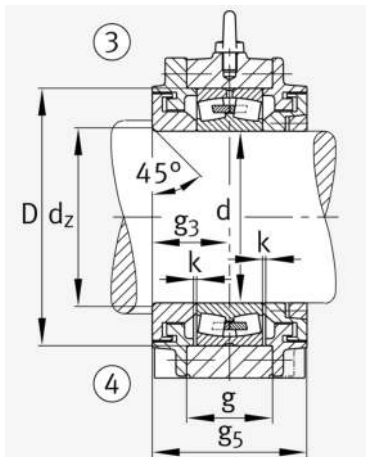

d 1	160 mm	Diámetro del eje
a	540 mm	Longitud de la base
h 1	360 mm	Altura total
g 1	200 mm	Anchura total
g 5	210 mm	
≈m	76 kg	Peso

**Medidas**

	45 °	Chamfer angle
b	200 mm	Anchura de la base
c	55 mm	Height base foot
D	270 mm	Outside Diameter
d <sub>c</sub>	168 mm	Chamfer diameter c
g	110 mm	Anchura del cuerpo de soporte
g <sub>3</sub>	105 mm	Locking collar width g3
g <sub>4</sub>	87 mm	Anchura del anillo tensor g4
h	180 mm	Distance shaft axis
k	3 mm	Axial displacement
m	430 mm	Distance fixing bore
n	110 mm	Bore distance width
s	M24	Tamaño de los tornillos de fijación
s <sub>2</sub>	M16	
s <sub>2</sub>	6	Número de agujeros roscados
t	310 mm	Diámetro primitivo de rodadura de los agujeros de fijación
u	30 mm	Anchura del agujero alargado
v	35 mm	Lenght oblong hole

**Información adicional**

	23132	Referencia rodamiento
--	-------	-----------------------

**Rango de temperatura**

T <sub>min</sub>	-20 °C	Temperatura mín. de funcionamiento
T <sub>max</sub>	100 °C	Temperatura máx. de funcionamiento

