

**MDKUBE35-500-3ZR-W2-N**

Módulo lineal

Tandem actuators with four-row linear recirculating bearing and guideway assembly, monorail guidance system and toothed belt drive. With triple toothed belt, second, driven carriage and fixing slots in carriage

Información técnica

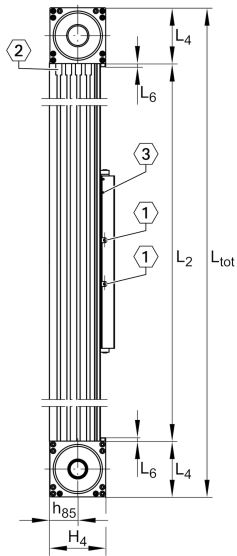
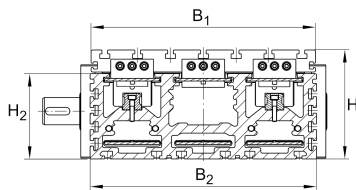

Variante de su producto actual

Size code	35	
Length of carriage	500	500 mm
Ejecución	/	Basis
Drive type	(3)ZR	Toothed belt drive
Additional carriage	W2	Second, driven carriage
Attachment to the carriage	N	T-Slots
n.r.		

/ Support Rail Design

Medidas principales y datos de rendimiento

B 2	415 mm	Total Width
H	200 mm	Total Height
L	500 mm	Length of Carriage

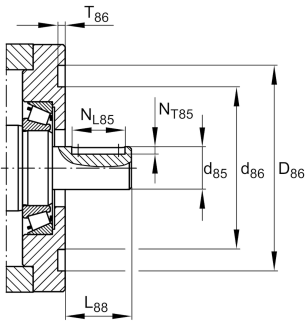
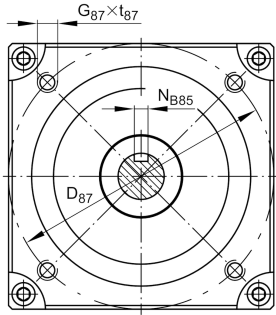
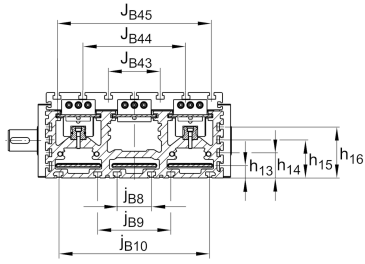

Medidas de montaje

B 1	410 mm	Width of Carriage
D 86	150 mm	
Tol D 86	G7	Tolerance
D 87	212 mm	
d 85	50 mm	Tolerance h7
d 86	138 mm	
G 87	M8	
h 13	30 mm	
h 14	60 mm	
h 56	30 mm	
J B43	120 mm	
j B8	80 mm	
L 2 max	6.000 mm	Maximum length of Support Rail
L 88	70 mm	
N B85	14 mm	Tolerance P9
N L85	45 mm	Length of Keyway
N T85	5,5 mm	Depth of Keyway
t 87 max	27 mm	Depth of Thread
j B9	170 mm	
j B10	350 mm	
J B44	240 mm	
J B45	360 mm	

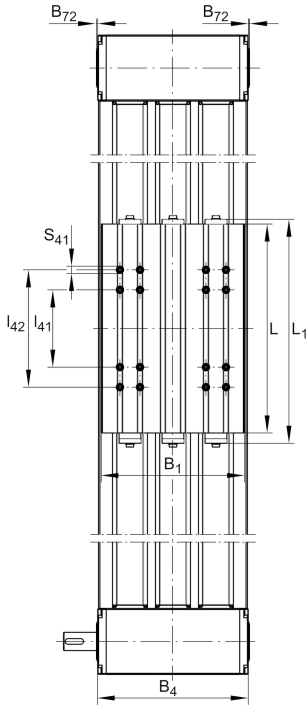

Medidas

B 72	2 mm	
H 2	157 mm	Height of Support Rail
H 4	173 mm	Height of Return Unit
h 85	88 mm	
L 1	538 mm	
L 4	170 mm	Length of Return Unit
L 6	10 mm	Length of Wiper Brushes
L x1 min	100 mm	
B 4	447,5 mm	Width of Return Unit
T 86	4 mm	Depth Fit

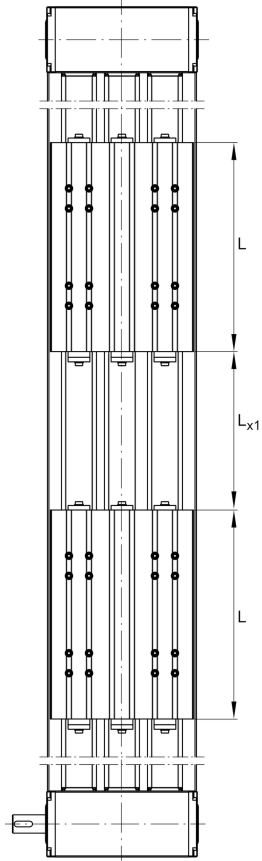
**Datos técnicos**

R_x	262 mm	
R_y	92,5 mm	
R_z	260 mm	
S	85 mm	Safety Distance
m_{LAW}	42,3 kg	
m_3	42,3 kg	Mass of additional Carriage
v_{max}	5 m/s	Maximum Speed
a_{max}	30 m/s ²	Maximum Acceleration
I C	100.200 N	Load direction I: compressive load
I C ₀	288.000 N	Load direction I: compressive load
II C	100.200 N	Load direction II: tensile load
II C ₀	288.000 N	Load direction II: tensile load
III C	100.200 N	Load direction III: lateral load
III C ₀	288.000 N	Load direction III: lateral load
$M_{0x \text{ per}}$	33.800 Nm	Max. permissible static moment per Carriage
$M_{0y \text{ per}}$	20.200 Nm	Max. permissible static moment per Carriage
$M_{0z \text{ per}}$	24.000 Nm	Max. permissible static moment per Carriage
I_y	42.680 cm ⁴	Geometrical moments of inertia of Support Rail
I_z	5.030 cm ⁴	Geometrical moments of inertia of Support Rail

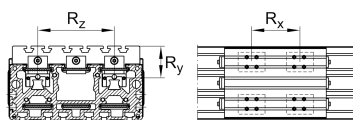
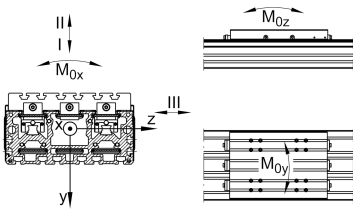



Información adicional

850 Nm	Max. permissible drive torque
4xKWVE35-B-H	Carriage
0,1 mm	Repeat Accuracy ±
370 mm	Feed (mm/rotation)
100ATK10L	Toothed Belt
2,06 kg/m	Mass of Toothed Belt
15.000 N	Permissible Toothed Belt operating force
892 kg*cm ²	Mass moment of inertia of Gears

Rango de temperatura

max	80 °C	Maximum operating Temperatur
min	0 °C	Minimum operating Temperatur