

**LTE40-230-B-1** [↗](#)

Mesa lineal

Linear tables with closed shaft guidance system, without drive, with shaft support block type B, with bellows

Información técnica

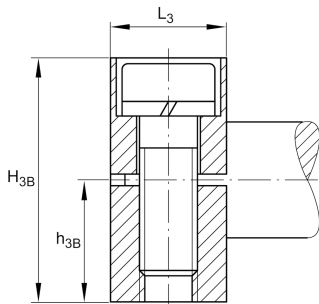
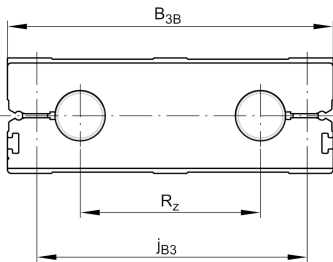

Variante de su producto actual

Size code	40	indicación de tamaño
Length of carriage	230	230 mm
Version	B	
Drive type	OA	Without drive
Bellow	1	Yes

Medidas principales y datos de rendimiento

B ₁	230 mm	Total Width
L	230 mm	Length of Carriage

Medidas de montaje

B _{3B}	230 mm	Width of Shaft Support Blocks
G ₃	M16	Thread
G ₄₃	M16	Thread
J _{B43}	202 mm	
J _{L43}	202 mm	
j _{B3}	190 mm	
j _{L3}	15 mm	
K ₄₃	M12	Thread
S ₃	26 mm	
T ₃	14,5 mm	
t ₄₃	34 mm	Depth of Thread

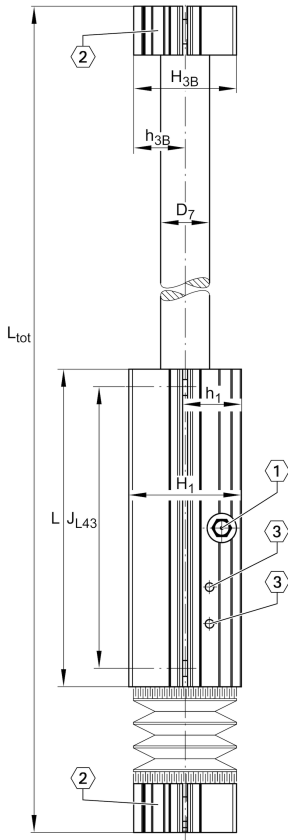

Medidas

B _B	22 mm	Length of Bellows Fastener
F _{BL}	1,28	Effective length factor of bellow
H ₁	80 mm	Height of Carriage
H _{3B}	72 mm	Height of Shaft Support Blocks
h ₁	40 mm	
h _{3B}	36 mm	
L ₃	30 mm	Length of Shaft Support Blocks
D ₇	40 mm	Ø Shaft, Tolerance h7

Datos técnicos

R _X	134 mm	
R _Z	122 mm	
m _{LAW}	10,3 kg	Mass of Carriage
v _{max}	5 m/s	Maximum Speed
a _{max}	50 m/s ²	Maximum Acceleration
C _I	15.830 N	Load direction I: compressive load
C _{0I}	17.600 N	Load direction I: compressive load
C _{II}	15.830 N	Load direction II: tensile load
C _{0II}	17.600 N	Load direction II: tensile load
C _{III}	15.830 N	Load direction III: lateral load
C _{0III}	17.600 N	Load direction III: lateral load
M _{0x per}	1.080 Nm	Max. permissible static moment per Carriage
M _{0y per}	970 Nm	Max. permissible static moment per Carriage
M _{0z per}	876 Nm	Max. permissible static moment per Carriage

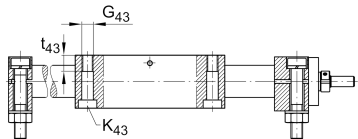
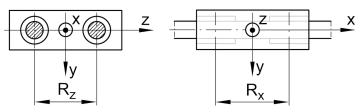
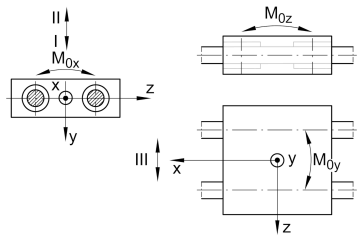
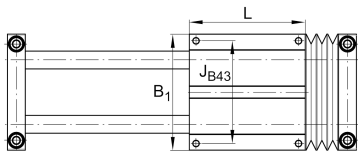

La hoja de datos solo contiene una descripción general de los datos técnicos del producto seleccionado. Consulte la documentación adicional de este producto. Para más información, utilice el siguiente enlace en nuestra página web: [Formulario de contacto](#)

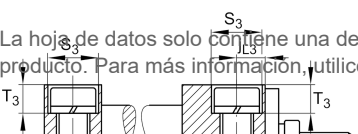



Información adicional

KB40-P

Linear Ball Bearings

Rango de temperatura

0 °C

Minimum operating Temperatur

80 °C

Maximum operating Temperatur