**LTE30-180-B-TR20x8-M-1**

## Mesa lineal

Linear tables with closed shaft guidance system and trapezoidal lead screw drive, with shaft support block type B, with bellows, with single nut

## Información técnica

## Variante de su producto actual

Size code	30	
Length of carriage	180	180 mm
Version	B	
Drive type	TGT	Trapezoidal screw drive
Spindle pitch	08	8 mm
Spindle diameter	20	20mm
Spindle nut design	M	Cylinder nut
Bellow	1	Yes

## Medidas principales y datos de rendimiento

B <sub>1</sub>	180 mm	Total Width
L	180 mm	Length of Carriage

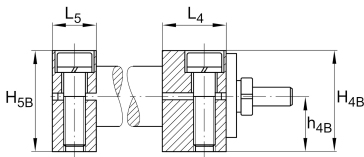
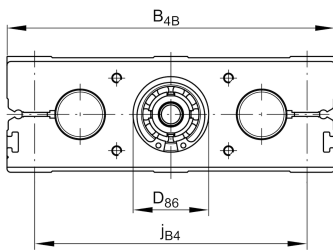

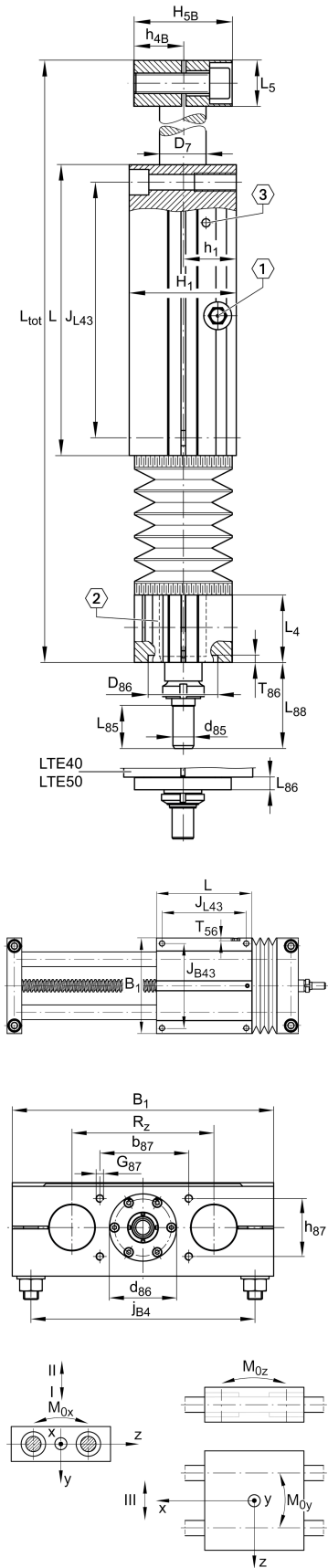

**Medidas de montaje**

B 4B	180 mm	Width of Shaft Support Blocks
b 87	68 mm	Tolerance $\pm 0,2$
D 86	32 mm	Tolerance H7
d 85	10 mm	Tolerance h7
d 86	0 mm	Tolerance g7
G 3	M12	Thread
G 43	M12	Thread
G 87	M6x15	Thread
h 85	35 mm	
h 87	44 mm	Tolerance $\pm 0,2$
J B43	158 mm	
J L43	158 mm	
j B4	150 mm	
j L3	12,5 mm	
K 43	M10	Thread
L 85	18 mm	
L 88	36,5 mm	
S 3	20 mm	
T 3	15,5 mm	
t 43	26 mm	Depth of Thread
T 86	2,8 mm	



## Medidas

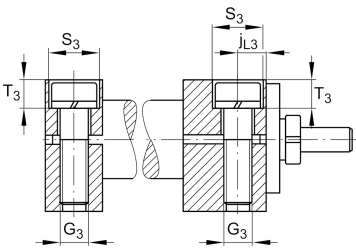
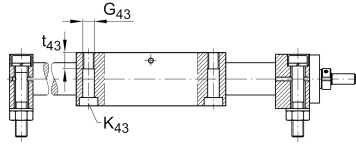

B B	21 mm	Length of Bellows Fastener
F <sub>BL</sub>	1,27	Effective length factor of bellow
H <sub>1</sub>	64 mm	Height of Carriage
H <sub>4B</sub>	58 mm	Height of Shaft Support Blocks
H <sub>5B</sub>	58 mm	Height of Shaft Support Blocks
h <sub>1</sub>	32 mm	
h <sub>4B</sub>	29 mm	
h <sub>5B</sub>	29 mm	
L <sub>4</sub>	38 mm	Length of Shaft Support Block with Drive System
L <sub>5</sub>	25 mm	Length of Shaft Support Block without drive System
D <sub>7</sub>	30 mm	Ø Shaft, Tolerance h7



### Datos técnicos

R <sub>x</sub>	98,6 mm	
R <sub>z</sub>	96 mm	
S	8 mm	Safety Distance
m <sub>LAW</sub>	5,04 kg	Mass of Carriage
v <sub>max</sub>	0,2 m/s	Maximum Speed
a <sub>max</sub>	2,5 m/s <sup>2</sup>	Maximum Acceleration
C <sub>I</sub>	9.500 N	Load direction I: compressive load
C <sub>0I</sub>	11.400 N	Load direction I: compressive load
C <sub>II</sub>	9.500 N	Load direction II: tensile load
C <sub>0II</sub>	11.400 N	Load direction II: tensile load
C <sub>III</sub>	9.500 N	Load direction III: lateral load
C <sub>0III</sub>	11.400 N	Load direction III: lateral load
M <sub>0x per</sub>	540 Nm	Max. permissible static moment per Carriage
M <sub>0y per</sub>	503 Nm	Max. permissible static moment per Carriage
M <sub>0z per</sub>	393 Nm	Max. permissible static moment per Carriage
d <sub>0</sub>	20 mm	Spindle Diameter
P	8 mm	Spindle Pitch
C <sub>0</sub>	2.550 N	Load capacity Spindle Nut stat
C <sub>0a</sub>	2.550 N	Load capacity fixed Spindle bearing stat

### Información adicional

	10 Nm	Max. permissible drive torque
	KB30-P	Linear Ball Bearings
	2 x 7201-2RS	Rolling Bearings (locating bearing)
	0,25 mm	Repeat accuracy ±
	0,81 kg*cm <sup>2</sup>	Mass moment of inertia of threaded Spindle



### Rango de temperatura

---

0 °C

Minimum operating Temperatur

80 °C

Maximum operating Temperatur