

**LTE30-180-B-0** [↗](#)

Mesa lineal

Linear tables with closed shaft guidance system, without drive, with shaft support block type B, without bellows

Información técnica

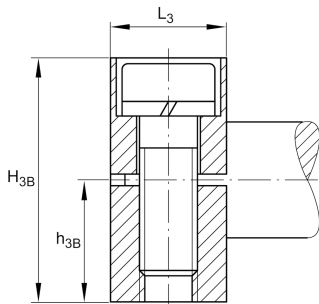
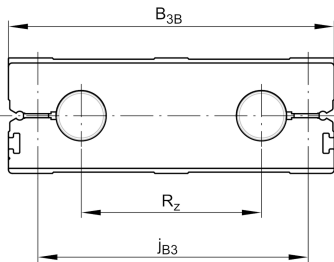

Variante de su producto actual

Size code	30	
Length of carriage	180	180 mm
Version	B	
Drive type	OA	Without drive
Bellow	0	No

Medidas principales y datos de rendimiento

B ₁	180 mm	Total Width
L	180 mm	Length of Carriage

Medidas de montaje

B _{3B}	180 mm	Width of Shaft Support Blocks
G ₃	M12	Thread
G ₄₃	M12	Thread
J _{B43}	158 mm	
J _{L43}	158 mm	
j _{B3}	150 mm	
j _{L3}	12,5 mm	
K ₄₃	M10	Thread
S ₃	20 mm	
T ₃	15,5 mm	
t ₄₃	26 mm	Depth of Thread

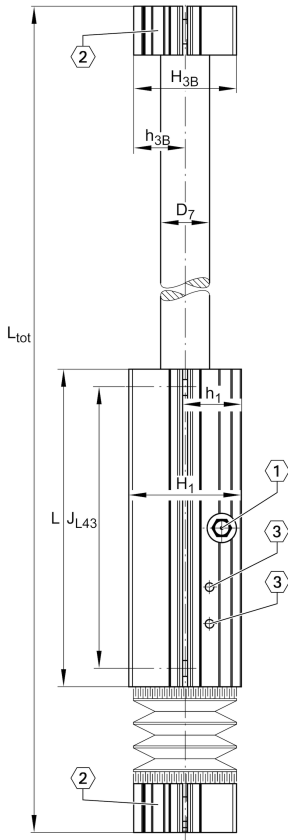

Medidas

H ₁	64 mm	Height of Carriage
H _{3B}	58 mm	Height of Shaft Support Blocks
h ₁	32 mm	
h _{3B}	29 mm	
L ₃	25 mm	Length of Shaft Support Blocks
D ₇	30 mm	Ø Shaft, Tolerance h7

Datos técnicos

R _X	98,6 mm	
R _Z	96 mm	
m _{LAW}	5,1 kg	Mass of Carriage
v _{max}	5 m/s	Maximum Speed
a _{max}	50 m/s ²	Maximum Acceleration
C _I	9.500 N	Load direction I: compressive load
C _{0I}	11.400 N	Load direction I: compressive load
C _{II}	9.500 N	Load direction II: tensile load
C _{0II}	11.400 N	Load direction II: tensile load
C _{III}	9.500 N	Load direction III: lateral load
C _{0III}	11.400 N	Load direction III: lateral load
M _{0x per}	540 Nm	Max. permissible static moment per Carriage
M _{0y per}	503 Nm	Max. permissible static moment per Carriage
M _{0z per}	393 Nm	Max. permissible static moment per Carriage

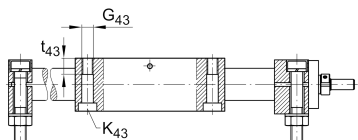
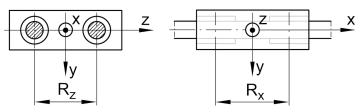
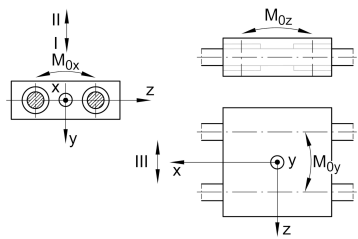
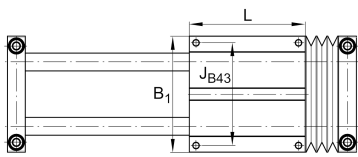

La hoja de datos solo contiene una descripción general de los datos técnicos del producto seleccionado. Consulte la documentación adicional de este producto. Para más información, utilice el siguiente enlace en nuestra página web: [Formulario de contacto](#)

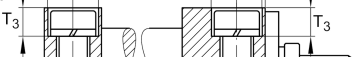



Información adicional

KB30-P

Linear Ball Bearings

Rango de temperatura

0 °C

Minimum operating Temperatur

80 °C

Maximum operating Temperatur