

**LTE30-180-A-2050-M-0** [↗](#)

Mesa lineal

Linear tables with closed shaft guidance system and ball screw drive, with shaft support block type A, without bellows, with single nut

Información técnica

Variante de su producto actual

Size code	30	
Length of carriage	180	180 mm
Version	A	
Drive type	KGT	Ball screw drive
Spindle pitch	50	50 mm
Spindle diameter	20	20mm
Spindle nut design	M	Cylinder nut
Bellow	0	No

Medidas principales y datos de rendimiento

B ₁	180 mm	Total Width
H	67 mm	Total Height
L	180 mm	Length of Carriage

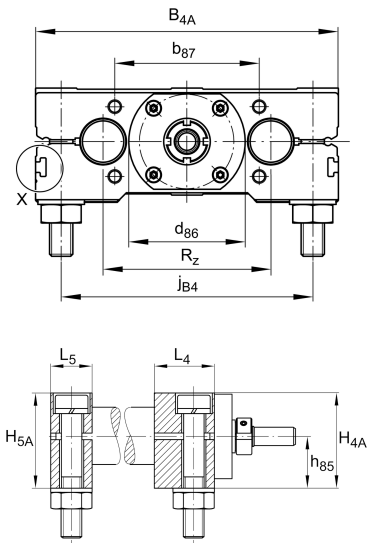



Medidas de montaje

B 4A	180 mm	Width of Shaft Support Blocks
b 87	68 mm	Tolerance $\pm 0,2$
D 3	13,5 mm	
d 85	10 mm	Tolerance h7
d 86	60 mm	Tolerance g7
G 43	M12	Thread
G 87	M6x15	Thread
h 85	35 mm	
h 87	44 mm	Tolerance $\pm 0,2$
J B43	158 mm	
J L43	158 mm	
j B4	150 mm	
j L3	12,5 mm	
K 43	M10	Thread
L 85	18 mm	
L 86	9 mm	
L 88	36,5 mm	
S 3	20 mm	
T 3	15,5 mm	
t 43	26 mm	Depth of Thread



Medidas

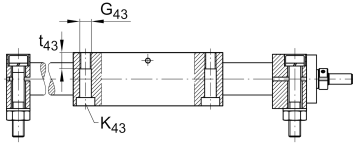

H 1	64 mm	Height of Carriage
H 4A	64 mm	Height of Shaft Support Blocks
H 5A	64 mm	Height of Shaft Support Blocks
h 1	32 mm	
L 4	38 mm	Length of Shaft Support Block with Drive System
L 5	25 mm	Length of Shaft Support Block without drive System
D 7	30 mm	Ø Shaft, Tolerance h7

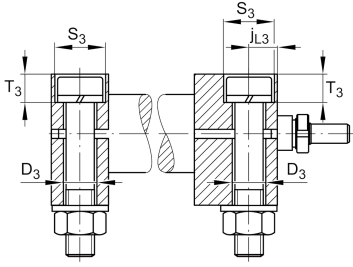
**Datos técnicos**

R _X	98,6 mm	
R _Z	96 mm	
S	50 mm	Safety Distance
m _{LAW}	5,04 kg	Mass of Carriage
v _{max}	2,9 m/s	Maximum Speed
a _{max}	20 m/s ²	Maximum Acceleration
C _I	9.500 N	Load direction I: compressive load
C _{0I}	11.400 N	Load direction I: compressive load
C _{II}	9.500 N	Load direction II: tensile load
C _{0II}	11.400 N	Load direction II: tensile load
C _{III}	9.500 N	Load direction III: lateral load
C _{0III}	11.400 N	Load direction III: lateral load
M _{0x per}	540 Nm	Max. permissible static moment per Carriage
M _{0y per}	503 Nm	Max. permissible static moment per Carriage
M _{0z per}	393 Nm	Max. permissible static moment per Carriage
d ₀	20 mm	Spindle Diameter
P	50 mm	Spindle Pitch
C	13.000 N	Load capacity Spindle Nut dyn
C ₀	24.600 N	Load capacity Spindle Nut stat
C _a	17.900 N	Load capacity fixed Spindle bearing dyn
C _{0a}	28.000 N	Load capacity fixed Spindle bearing stat

Información adicional

17 Nm	Max. permissible drive torque
KB30-P	Linear Ball Bearings
ZKLN1545-2RS-PE	Rolling Bearings (locating bearing)
0,05 mm	Repeat accuracy ±
0,845 kg*cm ²	Mass moment of inertia of threaded Spindle



Rango de temperatura

0 °C

Minimum operating Temperatur

80 °C

Maximum operating Temperatur