**MLFI200-500-3ZR-N-FA517.1** [↗](#)

Módulo lineal

Actuators with internal track roller guidance system and toothed belt drive. With triple toothed belt, support rail in two segments and fixing slots in carriage

Información técnica

Variante de su producto actual

Size code	200	
Length of carriage	500	500 mm
Version	/	Standard
Ejecución	/	Basis
Drive type	(3)ZR	Toothed belt drive
Additional carriage	/	No additional carriage
Attachment to the carriage	N	T-Slots
Support rail design	FA517.1	Two-Piece

Medidas principales y datos de rendimiento

B ₂	260 mm	Total Width
H	145 mm	Altura
L	500 mm	Longitud

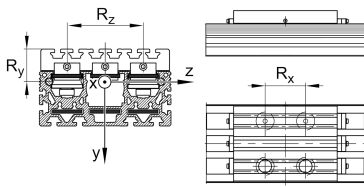
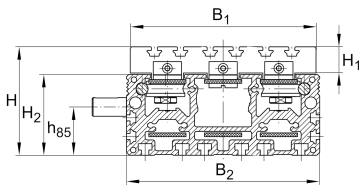

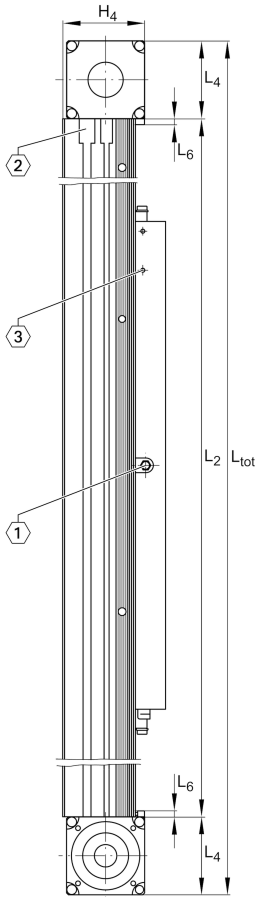

Medidas de montaje

D 86	95 mm	
Tol D 86	G7	Tolerance
D 87	115 mm	Ø Bolt circle
d 85	32 mm	
Tol d 85	h7	Tolerance
L 88	60 mm	
d 86	76 mm	Ø Inner Fit
G 87	M8	Thread
h 85	63 mm	
J B43	35 mm	
J B44	115 mm	
J B45	185 mm	
J B8	50 mm	
j B9	110 mm	
j B10	210 mm	
l 41	344 mm	
N B85	10 mm	Width of Keyway
N L85	32 mm	Length of Keyway
N T85	5 mm	Depth of Keyway, Tolerance P9
T 86	4 mm	Depth Fit
Tol T 86 up	0,5 mm	Upper Tolerance
Tol T 86 low	0 mm	Lower Tolerance
t 87 max	15 mm	

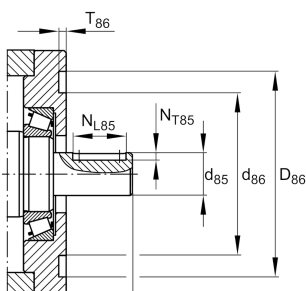
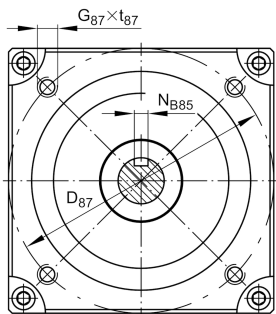
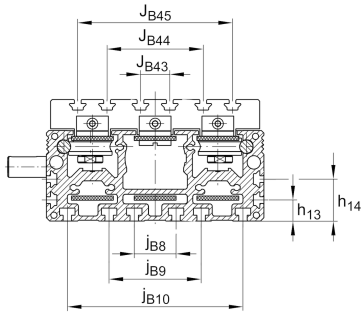

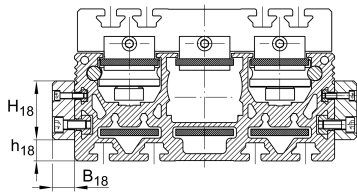
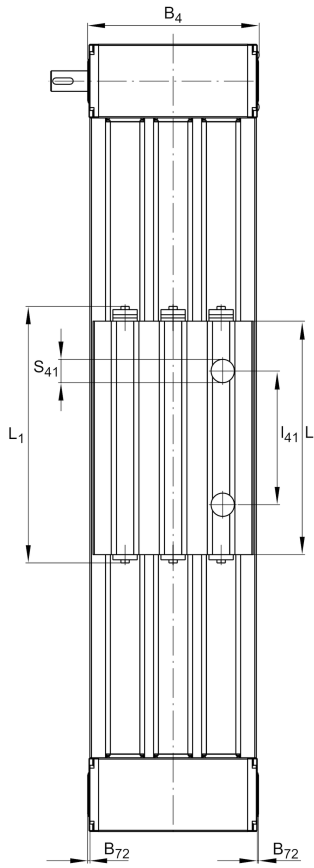

Medidas

B_1	250 mm	Width of Carriage
B_4	263 mm	Width of Return Unit
B_{18}	15 mm	
B_{72}	2 mm	
H_1	35 mm	Height of Carriage
H_2	108 mm	Altura
H_4	120,5 mm	Height of Return Unit
H_{18}	45 mm	
h_{13}	25 mm	
h_{14}	50 mm	
h_{18}	15 mm	
L_1	540 mm	Longitud
$L_{2 \text{ max}}$	16.000 mm	Maximum length of Support Rail
L_4	115,5 mm	
L_6	6 mm	Length of Wiper Brushes
L_{18}	400 mm	
$L_{Tn \text{ min}}$	500 mm	Support Rail in Segments length min
$L_{Tn \text{ max}}$	8.000 mm	Support Rail in Segments length max
S_{41}	36,5 mm	
S	85 mm	Medida



Datos técnicos

m_{LAW}	16,5 kg	Mass of Carriage
m_1	1,84 kg	Mass of Connecting Plates of Profiles
v_{max}	8 m/s	Maximum Speed
a_{max}	40 m/s ²	Maximum Acceleration
R_x	344 mm	
R_y	56,3 mm	
R_z	155 mm	
I C	21.000 N	Load direction I: compressive load
I C ₀	9.400 N	Load direction I: compressive load
II C	21.000 N	Load direction II: tensile load
II C ₀	9.400 N	Load direction II: tensile load
III C	35.000 N	Load direction III: lateral load
III C ₀	19.500 N	Load direction III: lateral load
$M_{0x \text{ per}}$	1.000 Nm	Max. permissible static moment per Carriage
$M_{0y \text{ per}}$	3.360 Nm	Max. permissible static moment per Carriage
$M_{0z \text{ per}}$	1.600 Nm	Max. permissible static moment per Carriage
I_y	7.069 cm ⁴	Geometrical moments of inertia of Support Rail
I_z	899 cm ⁴	Geometrical moments of inertia of Support Rail

Información adicional

207 Nm	Max. permissible drive torque
4 x LFR5204-16-2Z	Track Rollers
0,1 mm	Repeat Accuracy ±
230 mm	Feed (mm/rotation)
50AT10	Toothed Belt
0,945 kg/m	Mass of Toothed Belt
5.640 N	Permissible Toothed Belt operating force
35,2 kg*cm ²	Mass moment of inertia of Gears and Gearboxes

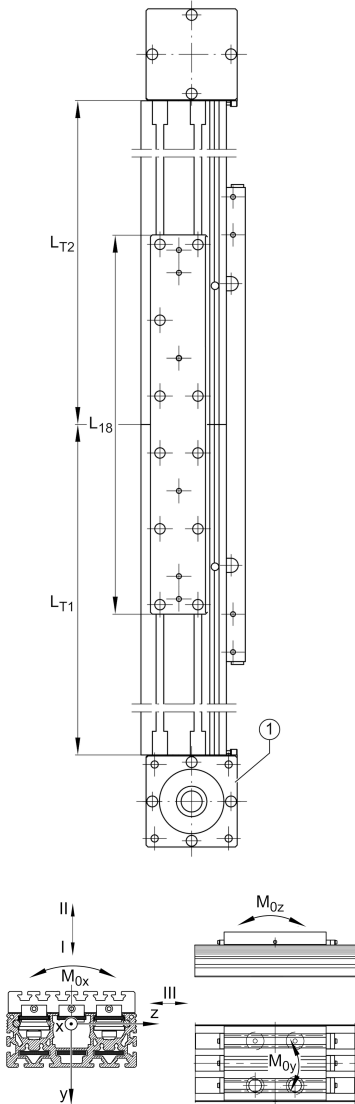



Rango de temperatura

T_{min} 0 °C Minimum operating Temperatur

T_{max} 80 °C Maximum operating Temperatur