

MDKUSE25-365-KGT/10-F-SPU-WN2-N [↗](#)

Módulo lineal

Tandem actuators with six-row linear recirculating bearing and guideway assembly, monorail guidance system and ball screw drive. With second, non-driven carriage, single nut, single spindle support and fixing slots in carriage.

Información técnica



Variante de su producto actual

Size code	25	
Length of carriage	365	365 mm
Drive type	KGT	Ball screw drive
Spindle pitch	10	10 mm
Spindle nut design	F	Flange nut
Additional carriage	WN2	Second, non-driven carriage
Spindle support	SPU	Yes
Attachment to the carriage	N	T-Slots

Medidas principales y datos de rendimiento

L	365 mm	Length of Carriage
H	145 mm	Total Height
B 2	260 mm	Total Width

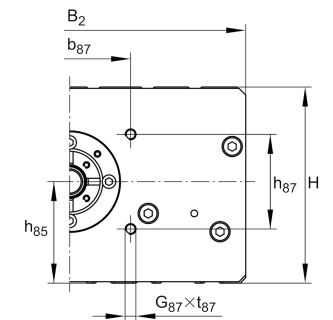

Medidas de montaje

B 1	250 mm	Width of Carriage
b 87	90 mm	
d 85	19 mm	
Tol d 85	h6	Tolerance
d 86	75 mm	
Tol d 86	h7	Tolerance
G 87	M8	Thread
h 13	25 mm	
h 14	50 mm	
h 85	75 mm	
h 87	70 mm	
J B43	35 mm	
J B44	115 mm	
J B45	185 mm	
j B8	50 mm	
j B9	110 mm	
j B10	210 mm	
L 2 max	5.850 mm	Maximum length of Support Rail
L 85	28 mm	
L 86	9 mm	
L 88	67 mm	
N B43	14 mm	
N B85	6 mm	Tolerance P9
N L43	20 mm	
N L85	20 mm	Length of Keyway
N T85	3,5 mm	Depth of Keyway
t 87	20 mm	Depth of Thread



Medidas

B_5	259 mm	Width of End Plates
F_{BL}	1,18	Effective length factor of bellow
H_1	35 mm	Height of Carriage
H_2	108 mm	Width of Support Rail
H_5	144 mm	
L_4	33 mm	
L_5	28 mm	
L_{72}	2 mm	
I_{41}	30 mm	
I_{42}	35 mm	
$L_{x1 \min}$	20 mm	Minimum distance between the Carriages
S_{41}	13 mm	

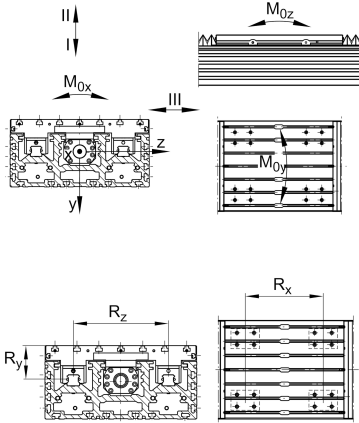

**Datos técnicos**

R_x	270 mm	
R_y	69,3 mm	
R_z	150 mm	
S	10 mm	Safety Distance
m_{LAW}	12,84 kg	Mass of Carriage
m_3	11,28 kg	Mass of additional Carriage
v_{max}	0,43 m/s	Maximum Speed
a_{max}	20 m/s ²	Maximum Acceleration
IC	100.200 N	Load direction I: compressive load
IC ₀	324.000 N	Load direction I: compressive load
II C	68.600 N	Load direction II: tensile load
II C ₀	180.000 N	Load direction II: tensile load
III C	73.800 N	Load direction III: lateral load
III C ₀	188.000 N	Load direction III: lateral load
$M_{0x\ per}$	13.500 Nm	Max. permissible static moment per Carriage
$M_{0y\ per}$	16.200 Nm	Max. permissible static moment per Carriage
$M_{0z\ per}$	15.500 Nm	Max. permissible static moment per Carriage
I_y	7.069 cm ⁴	Geometrical moments of inertia of Support Rail
I_z	899 cm ⁴	Geometrical moments of inertia of Support Rail
$C_{a\ MU}$	33.400 N	Load capacity spindle nut dyn
$C_{0a\ MU}$	54.500 N	Load capacity spindle nut stat
$C_{a\ L}$	27.500 N	Load capacity fixed Spindle bearing dyn
$C_{0a\ L}$	55.000 N	Load capacity fixed Spindle bearing stat
d_0	32 mm	Spindle Diameter
P	10 mm	Spindle Pitch
I_s	6,43 kg*cm ²	Mass moment of inertia of threaded Spindle
SPU	Ja	Spindle Support
WN2	ja	Second, non-driven Carriage



Ver detalles del producto en Medias

11.11.2025, 17:58:07 UTC

SCHAEFFLER

Información adicional

ZKLF2575-2RS-PE	Rolling Bearings
-----------------	------------------

F	Drive System
---	--------------

4x KWSE25-H	Carriage
-------------	----------