

**MKUSE25-500-ZR-FA517.1** [↗](#)

Módulo lineal

Actuators with six-row linear recirculating bearing and guideway assembly, monorail guidance system and toothed belt drive. With support rail in two segments

Información técnica

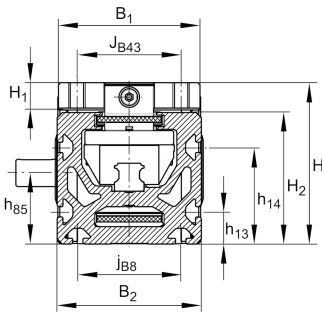

Variante de su producto actual

Size code	25	
Length of carriage	500	500 mm
Ejecución	/	Basis
Drive type	(3)ZR	Toothed belt drive
Additional carriage	/	No additional carriage
Attachment to the carriage	/	Threaded holes

n.r.

FA517.1

Support Rail Design

Medidas principales y datos de rendimiento

B 2	112 mm	Total Width
H	125 mm	Total Height
L	500 mm	Length of Carriage

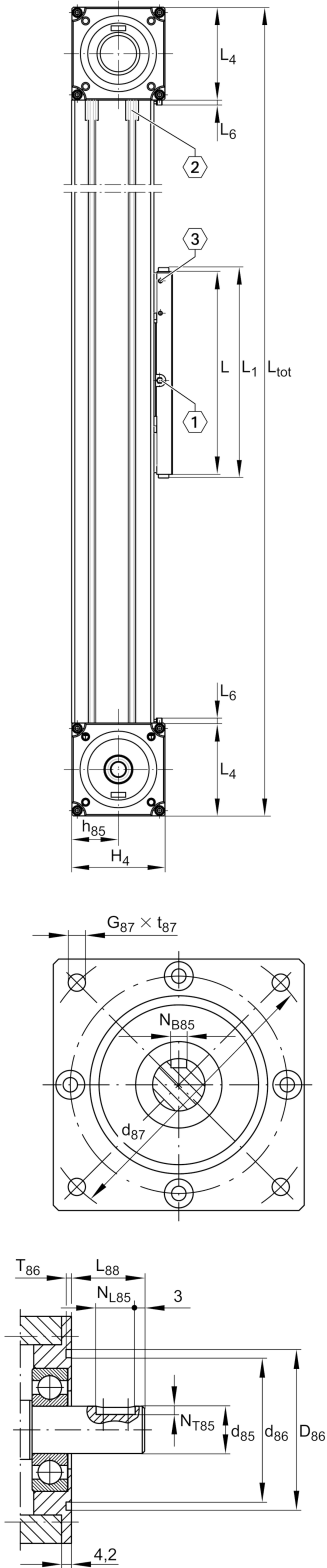

Medidas de montaje

B 1	110 mm	Width of Carriage
D 86	95 mm	
Tol D 86	G7	Tolerance
D 87	115 mm	
d 85	20 mm	Tolerance h7
d 86	76 mm	
G 43	M10	
G 87	M8	
h 13	25 mm	
h 14	75 mm	
h 18	5 mm	
J B43	80 mm	
Tol J B43	0,1	Upper Tolerance
Tol J B43	0,1	Lower Tolerance
J L43	90 mm	
J L44	270 mm	
J L45	450 mm	
j B8	80 mm	
L 2 max	16.000 mm	Maximum length of Support Rail
L 88	31 mm	
N B85	6 mm	Tolerance P9
N L85	25 mm	Length of Keyway
N T85	3,5 mm	Depth of Keyway
t 43 max	20 mm	Depth of Thread
t 87 max	15 mm	Depth of Thread

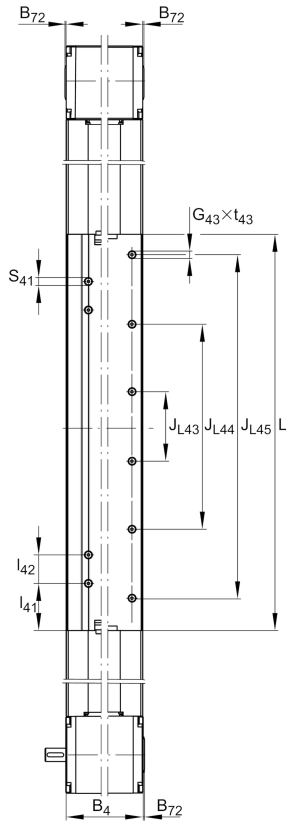

Medidas

B 18	15 mm	
B 72	2 mm	
H 1	21 mm	Height of Carriage
H 2	102 mm	Height of Support Rail
H 4	115,7 mm	Height of Return Unit
H 18	90 mm	
h 85	58 mm	
L 1	513 mm	
L 4	115,5 mm	Length of Return Unit
L 6	6 mm	Length of Wiper Brushes
L 18	400 mm	
B 4	111 mm	Width of Return Unit
T 86	4 mm	Depth Fit
Tol T 86	0 mm	Lower tolerance
Tol T 86	0,5 mm	Upper Tolerance

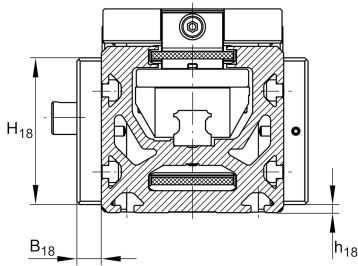



Datos técnicos

R_x	360 mm	
R_y	68,3 mm	
S	85 mm	Safety Distance
m LAW	6,61 kg	
v_{max}	5 m/s	Maximum Speed
a_{max}	30 m/s ²	Maximum Acceleration
I C	61.700 N	Load direction I: compressive load
I C ₀	162.000 N	Load direction I: compressive load
II C	42.200 N	Load direction II: tensile load
II C ₀	90.000 N	Load direction II: tensile load
III C	45.400 N	Load direction III: lateral load
III C ₀	94.000 N	Load direction III: lateral load
$M_{0x \text{ per}}$	1.380 Nm	Max. permissible static moment per Carriage
$M_{0y \text{ per}}$	11.200 Nm	Max. permissible static moment per Carriage
$M_{0z \text{ per}}$	13.300 Nm	Max. permissible static moment per Carriage
I_y	712 cm ⁴	Geometrical moments of inertia of Support Rail
I_z	506 cm ⁴	Geometrical moments of inertia of Support Rail

Información adicional

75 Nm	Max. permissible drive torque
2xKWSE25	Carriage
0,1 mm	Repeat Accuracy ±
250 mm	Feed (mm/rotation)
50AT10	Toothed Belt
0,315 kg/m	Mass of Toothed Belt
1.880 N	Permissible Toothed Belt operating force
14,7 kg*cm ²	Mass moment of inertia of Gears

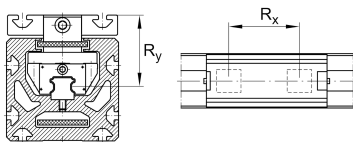
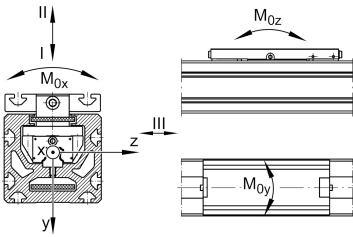
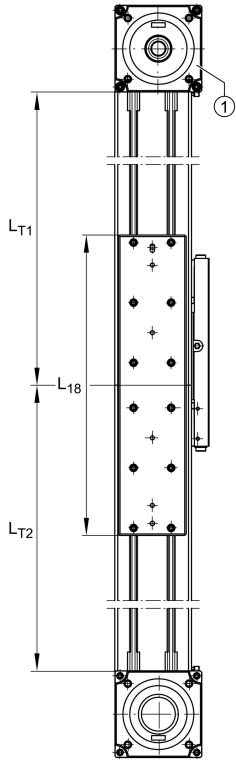



Rango de temperatura

max	80 °C	Maximum operating Temperatur
min	0 °C	Minimum operating Temperatur