**MKUSE25-250-ZR-FA517.1** [↗](#)

## Módulo lineal

Actuators with six-row linear recirculating bearing and guideway assembly, monorail guidance system and toothed belt drive. With support rail in two segments

## Información técnica

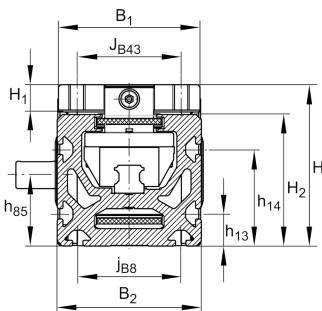

## Variante de su producto actual

Size code	25	
Length of carriage	250	250 mm
Ejecución	/	Basis
Drive type	(3)ZR	Toothed belt drive
Additional carriage	/	No additional carriage
Attachment to the carriage	/	Threaded holes

## n.r.

FA517.1

Support Rail Design

## Medidas principales y datos de rendimiento

B 2	112 mm	Total Width
H	125 mm	Total Height
L	250 mm	Length of Carriage

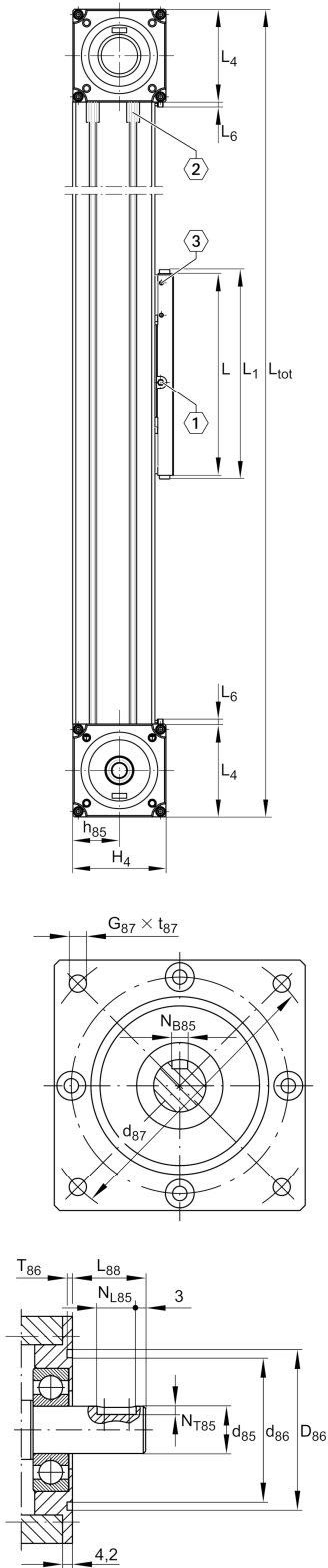

## Medidas de montaje

B 1	110 mm	Width of Carriage
D 86	95 mm	
Tol D 86	G7	Tolerance
D 87	115 mm	
d 85	20 mm	Tolerance h7
d 86	76 mm	
G 43	M10	
G 87	M8	
h 13	25 mm	
h 14	75 mm	
h 18	5 mm	
J B43	80 mm	
Tol J B43	0,1	Upper Tolerance
Tol J B43	0,1	Lower Tolerance
J L43	180 mm	
j B8	80 mm	
L 2 max	16.000 mm	Maximum length of Support Rail
L 88	31 mm	
N B85	6 mm	Tolerance P9
N L85	25 mm	Length of Keyway
N T85	3,5 mm	Depth of Keyway
t 43 max	20 mm	Depth of Thread
t 87 max	15 mm	Depth of Thread

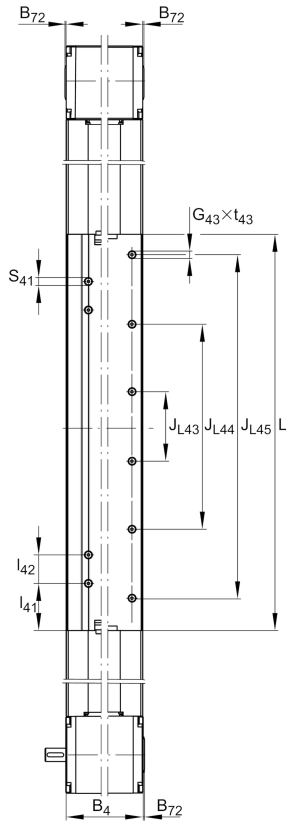

### Medidas

B 18	15 mm	
B 72	2 mm	
H 1	21 mm	Height of Carriage
H 2	102 mm	Height of Support Rail
H 4	115,7 mm	Height of Return Unit
H 18	90 mm	
h 85	58 mm	
L 1	263 mm	
L 4	115,5 mm	Length of Return Unit
L 6	6 mm	Length of Wiper Brushes
L 18	400 mm	
B 4	111 mm	Width of Return Unit
T 86	4 mm	Depth Fit
Tol T 86	0 mm	Lower tolerance
Tol T 86	0,5 mm	Upper Tolerance

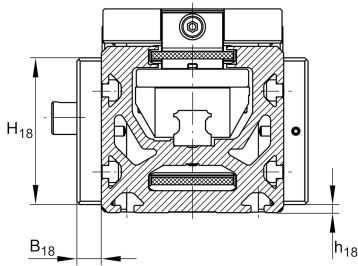



### Datos técnicos

$R_x$	110 mm	
$R_y$	68,3 mm	
S	85 mm	Safety Distance
$m_{LAW}$	4,15 kg	
$v_{max}$	5 m/s	Maximum Speed
$a_{max}$	30 m/s <sup>2</sup>	Maximum Acceleration
I C	61.700 N	Load direction I: compressive load
I C <sub>0</sub>	162.000 N	Load direction I: compressive load
II C	42.200 N	Load direction II: tensile load
II C <sub>0</sub>	90.000 N	Load direction II: tensile load
III C	45.400 N	Load direction III: lateral load
III C <sub>0</sub>	94.000 N	Load direction III: lateral load
$M_{0x \text{ per}}$	1.380 Nm	Max. permissible static moment per Carriage
$M_{0y \text{ per}}$	2.400 Nm	Max. permissible static moment per Carriage
$M_{0z \text{ per}}$	3.200 Nm	Max. permissible static moment per Carriage
$I_y$	712 cm <sup>4</sup>	Geometrical moments of inertia of Support Rail
$I_z$	506 cm <sup>4</sup>	Geometrical moments of inertia of Support Rail

### Información adicional

75 Nm	Max. permissible drive torque
2xKWSE25	Carriage
0,1 mm	Repeat Accuracy ±
250 mm	Feed (mm/rotation)
50AT10	Toothed Belt
0,315 kg/m	Mass of Toothed Belt
1.880 N	Permissible Toothed Belt operating force
14,7 kg*cm <sup>2</sup>	Mass moment of inertia of Gears

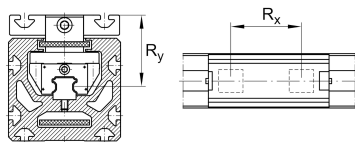
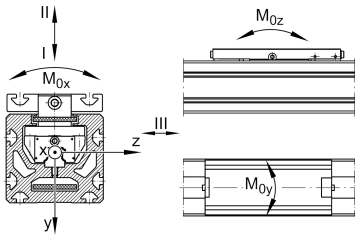
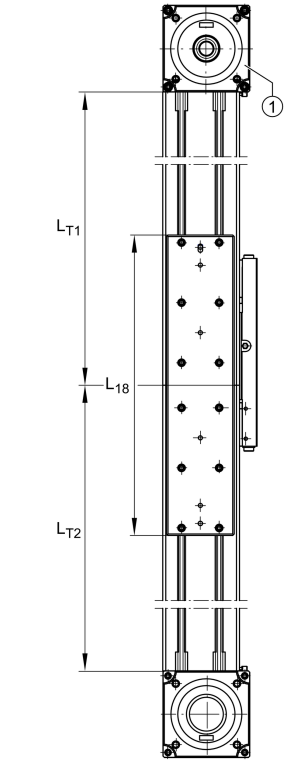



### Rango de temperatura

---

max	80 °C	Maximum operating Temperatur
min	0 °C	Minimum operating Temperatur