**PAGBAO30-PP-AS**

Unidad de rodamiento lineal de fricción

Linear plain bearing and housing unit; open design, sealed on all sides, with relubrication facility

Información técnica

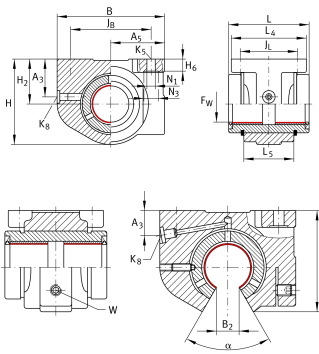

Variante de su producto actual

Size code	30
Seal	PP
Función de relubricación	AS

Medidas principales y datos de rendimiento

F _W	30 mm	Diameter of ball complement
H	63,5 mm	Height
L	68 mm	Longitud
Tol _L	h12	Tolerance
B	84 mm	Width
≈m	0,43 kg	Peso

**Medidas de montaje**

J _B	68 mm	
Tol J _B	+ 0,2 mm	Upper tolerance
Tol J _B	- 0,2 mm	Lower tolerance
A ₅	42 mm	
B ₂	13,6 mm	
L ₄	60 mm	
L ₅	48 mm	
J _L	45 mm	
Tol J _L	+ 0,2 mm	Upper tolerance
Tol J _L	- 0,2 mm	Lower tolerance
H ₂	35 mm	Center height
A ₃	14 mm	
H ₆	8,7 mm	
Tol H ₆	- 0,5 mm	Tolerance
N ₁	6,8 mm	Mounting Dimension
N ₃	11 mm	Mounting Dimension
K ₅	M6	
K ₈	NIPA2	Lubrication nipple
W	3 mm	Width across flats
M W _{max}	4 Nm	Max. tightening torque
α	54 °	Angle