

# HabasitLINK®

## Installation instructions for belt types M0863, M0863 MTW, M0870, M0870 MTW, M0873, M0876 and M0885

Please find full installation guide on [www.habasitlink.com](http://www.habasitlink.com)

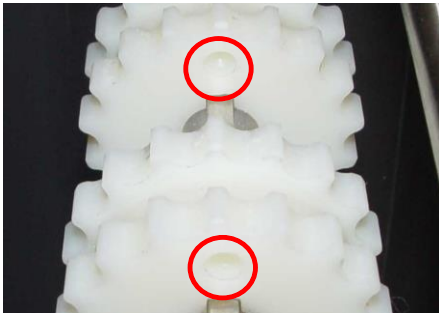

Sprocket alignment on the shafts:

**Corresponding teeth axial aligned, check by alignment mark.**

**If the bore is square and the number of teeth can be divided by 4, there may be no mark.**

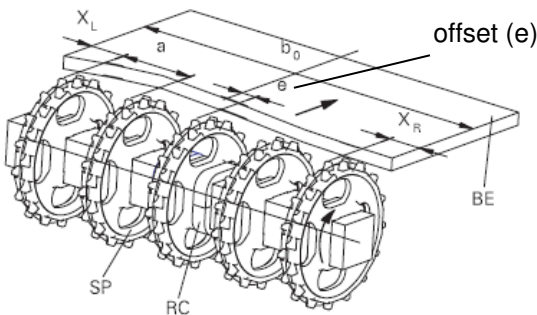

### Sprockets Positioning:

Place sprockets between min. and max. spacing (a).

Place outer most sprockets at first position from edge and respect distance  $X_L$  and  $X_R$ .

Fix only the sprocket in the center with small clearance.

Belt type	Sprocket spacing a		Edge distance (minimal)	
	minimal mm inch	maximal mm inch	$X_L$ mm inch	$X_R$ mm inch
M0863* M0870* M0876*	50.8 2	152.4 6	25.4 1	25.4 1
M0885	50.8 2	152.4 6	50.8 2	50.8 2
M0870 MTW M0873	50.8 2	152.4 6	38.1 1.5	38.1 1.5
M0863K03 (MTW)	-	-	38.1 1.5	38.1 1.5
M0863K02 (MTW)	-	-	24.0 0.95	24.0 0.95

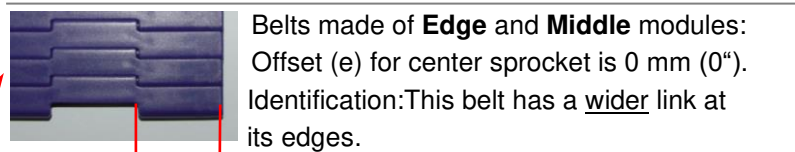

Belts made of **Edge** and **Middle** modules:  
Offset (e) for center sprocket is 0 mm (0").  
Identification: This belt has a wider link at its edges.

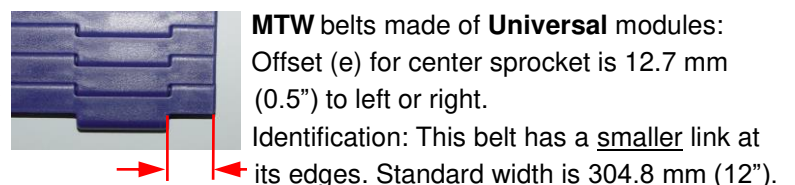

**MTW** belts made of **Universal** modules:  
Offset (e) for center sprocket is 12.7 mm (0.5") to left or right.  
Identification: This belt has a smaller link at its edges. Standard width is 304.8 mm (12").

\*For belts equipped with Saniclip, edge distance 50.8 mm (2")



### Check proper sprocket engagement:

The double teeth sprocket must properly engage in belt.

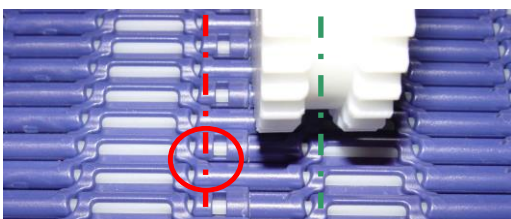

**NO** **Yes**

If a brick layed belt is assembled with universal modules **MTW** the sprockets must **Not** be placed at **rod retaining** module end (red line).

**Rod installation (snap fit rod retention):**

Use headless rods  $\text{\O}3.0\text{mm}$  (0.12") with retainer ring and beveled rod end.

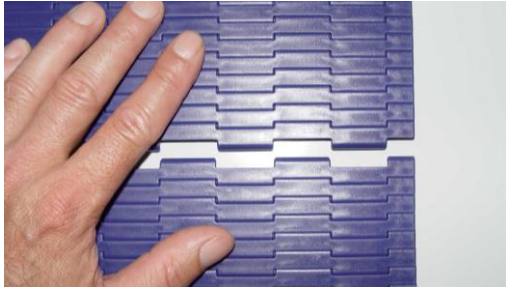

Pull belt sections together

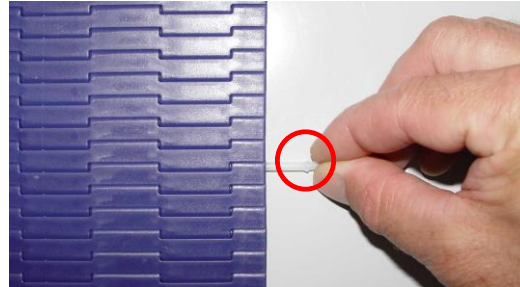

Insert rod. For easy rod installation, rod end must be beveled.

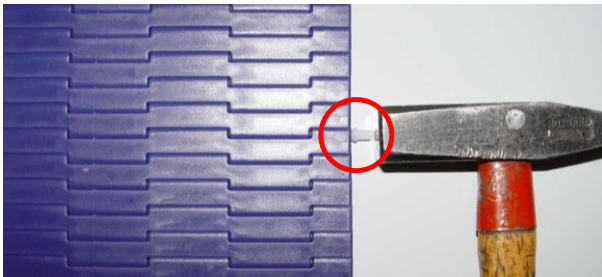

Hammer in rod

Check if **rod is fully embedded** (proper snapped in).

**Rod removal (snap fit rod retention):**

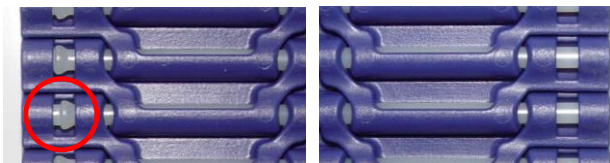

Find belt side with rod retaining ring

Punch rod out from this side

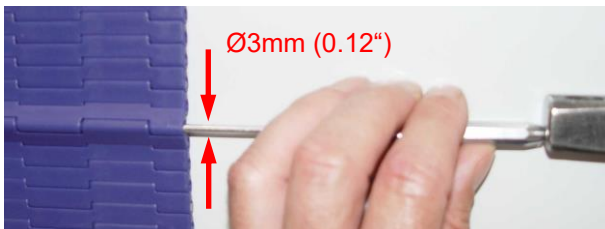

**Rod removal (by hammer and punch)**

Punch out of rod retaining ring by striking rod end **opposite to retaining ring**.

The belt must not be under tension.

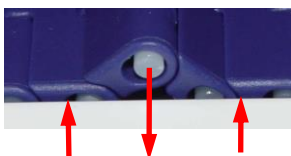

Hold back module edge on the opposite side.

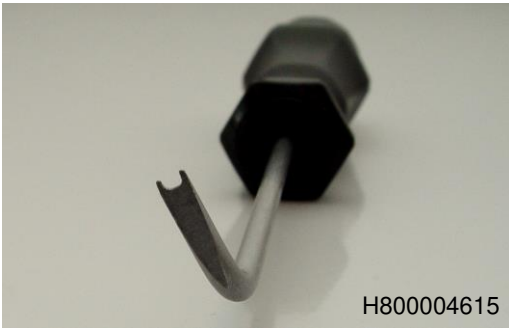

### Rod removal by Rod Puller 3 mm

For Series M0800 a cranked Rod Puller is available. It is mainly used for wide belts assembled with a long rod or multiple rods per module row.

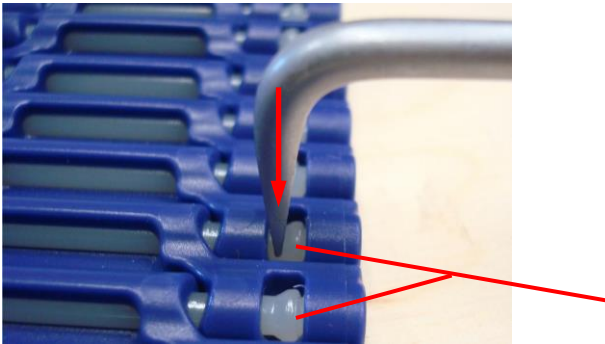

### Rod removal instruction:

Find belt edge with rod retainer ring at belt reverse side. For belt with multiple rods per row the retainer rings are on both edges.

Apply the Rod Puller behind the rod retainer ring.

### Rod retainer rings

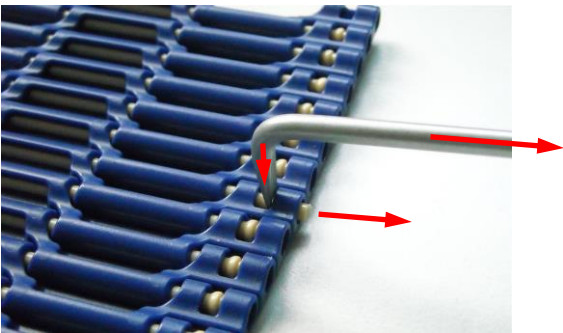

Keep the rod puller behind the retaining ring by pressing it firmly onto the rod. Pull the rod at the same time out of the outermost link.

### Warning: Rod pullers have sharp edges. Danger for injuries by wrong handling!

#### Respect following instructions:

- do not work in direction to hand or body
- do not use it as chisel or punch
- do not use it for prying
- do not use it in contact with electric appliances

#### Disclaimer

#### Product Application Disclaimer (valid for ALL Habasit products and mentioned on all PDS)

This disclaimer is made by and on behalf of Habasit and its affiliated companies, directors, employees, agents and contractors (hereinafter collectively "HABASIT") with respect to the products referred to herein (the "Products"). SAFETY WARNINGS SHOULD BE READ CAREFULLY AND ANY RECOMMENDED SAFETY PRECAUTIONS BE FOLLOWED STRICTLY! Please refer to the Safety Warnings herein, in the Habasit catalogue as well as installation and operating manuals. All indications / information as to the application, use and performance of the Products are recommendations provided with due diligence and care, but no representations or warranties of any kind are made as to their completeness, accuracy or suitability for a particular purpose. The data provided herein are based on laboratory application with small-scale test equipment, running at standard conditions, and do not necessarily match product performance in industrial use. New knowledge and experience may lead to re-assessments and modifications within a short period of time and without prior notice.

EXCEPT AS EXPLICITLY WARRANTED BY HABASIT, WHICH WARRANTIES ARE EXCLUSIVE AND IN LIEU OF ALL OTHER WARRANTIES, EXPRESS OR IMPLIED, THE PRODUCTS ARE PROVIDED "AS IS". HABASIT DISCLAIMS ALL OTHER WARRANTIES, EITHER EXPRESS OR IMPLIED, INCLUDING, BUT NOT LIMITED TO, IMPLIED WARRANTIES OF MERCHANTABILITY, FITNESS FOR A PARTICULAR PURPOSE, NON-INFRINGEMENT, OR ARISING FROM A COURSE OF DEALING, USAGE, OR TRADE PRACTICE, ALL OF WHICH ARE HEREBY EXCLUDED TO THE EXTENT ALLOWED BY APPLICABLE LAW. BECAUSE CONDITIONS OF USE IN INDUSTRIAL APPLICATION ARE OUTSIDE OF HABASIT'S CONTROL, HABASIT DOES NOT ASSUME ANY LIABILITY CONCERNING THE SUITABILITY AND PROCESS ABILITY OF THE PRODUCTS, INCLUDING INDICATIONS ON PROCESS RESULTS AND OUTPUT.



Installation flyer MOD-en 2107HQR